

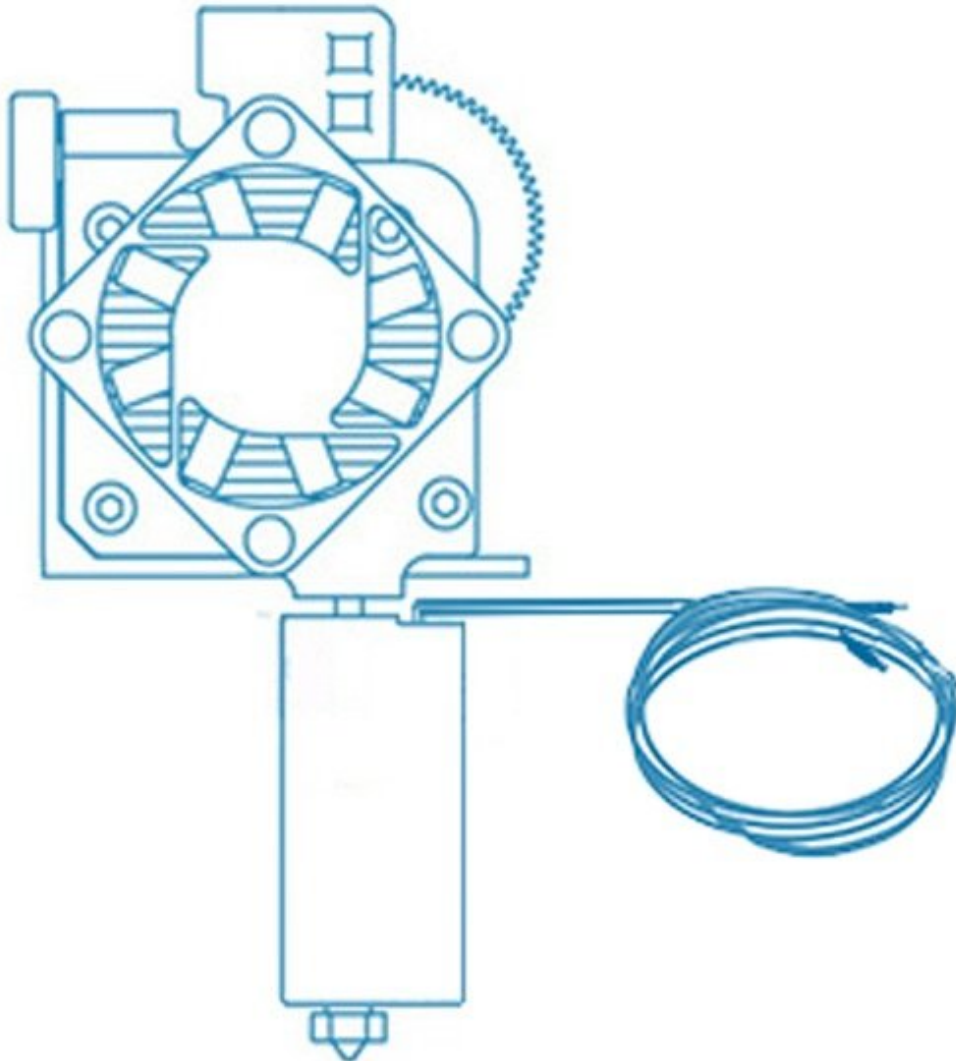

Super Volcano Assembly

Super Volcano Assembly instructions

Written By: Dan Rock



INTRODUCTION

Health and Safety Warnings

This product comes with high powered electronics. The assembly documentation must be followed. If you are still unsure of how to implement the system correctly, please contact our customer support team.

- The 12V Super Volcano heater draws up to 8A which is more than most controller boards can handle. Therefore it **cannot** be used without the included MOSFET switch which will handle the high current requirement. **Do, not** use the heater provided with any other block than the SuperVolcano block. Using the heater with another block might result in catastrophic failure of the system.
- Handling of the HotEnd must only be carried out with the printer switched off and the power cord unplugged from the socket. The SuperVolcano block will remain hot for longer than other HotEnds so allow extra time for the system to cool down.
- The SuperVolcano sock is made from glass fibre coated with silicone rubber when handling this, protective clothing must be worn.
- Please note care must be taken when bending the heater cartridge wires and not to bend them to a sharp point as this could snap the wires due to their gauge. Ensure not to fatigue the wires by repeatedly bending them as this will cause failure.
- The full health and safety warning can be found in the datasheet and must be adhered to.
- The Super Volcano uses the standard stainless steel V6 heatbreak, it is more than strong enough to be used in normal printing conditions. From our testing (we have run many kilos of filament at this point printing JIGs for production as well as all our SuperVolcano product testing) we have not found any issues with the heatbreak snapping during normal printing conditions. However, due to the leverage of the Super Volcano heater block, it is at a slightly higher risk of snapping/ bending if the head experiences any crashes. This could be from things such as aggressive z homing on the nozzle or colliding with large print artefacts or badly warping parts. We recommend that you avoid using overlapping infill patterns and use a large amount of z hop.



PARTS:

- Thermistor Cartridge (1)
- Extension Wires (1)
- Thermal Paste Sachet (1)
- Super Volcano Block. (1)
- Super Volcano Sock. (1)
- Super Volcano Fixings (1)
- Brass Super Volcano 1.75 Nozzle (1)
- 80W Heater Cartridge (1)
- M3 Grub Screw (4)
- MOSFET Board (1)

Step 1 — Assemble the Titan Aero



- The first step if you are building a new Titan Aero is to follow the standard Titan Aero guide.
- [Titan Aero Assembly](#)
- Step 14 is where you should begin as you will not be using the v6 heater block.

Step 2 — Gather components.

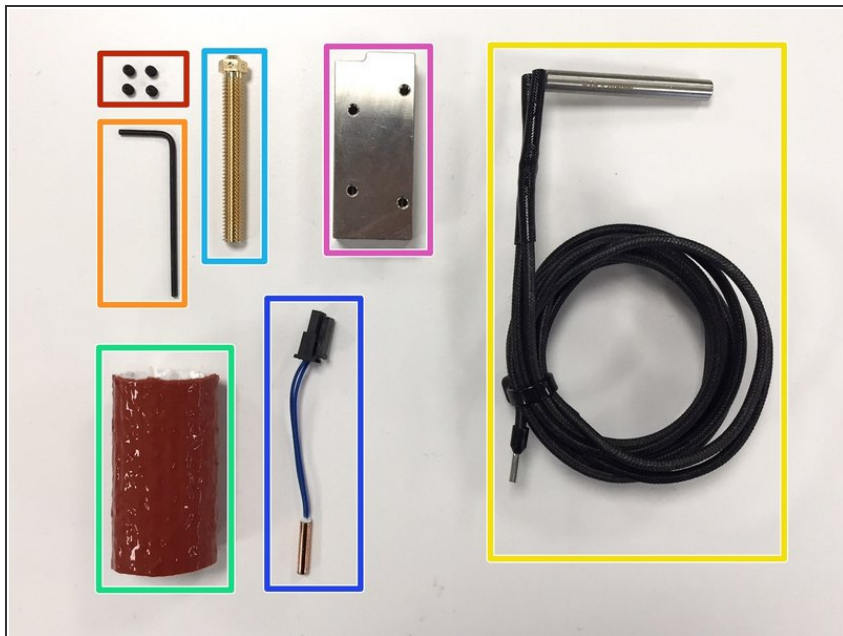

- x4 M3 grub screws.
- Hex key
- 50mm glass fibre silicone sleeve
- Thermistor cartridge
- Plated copper Volcano block.
- 0.8 mm super volcano nozzle.
- Heater cartridge.

Step 3 — Orient heater block.

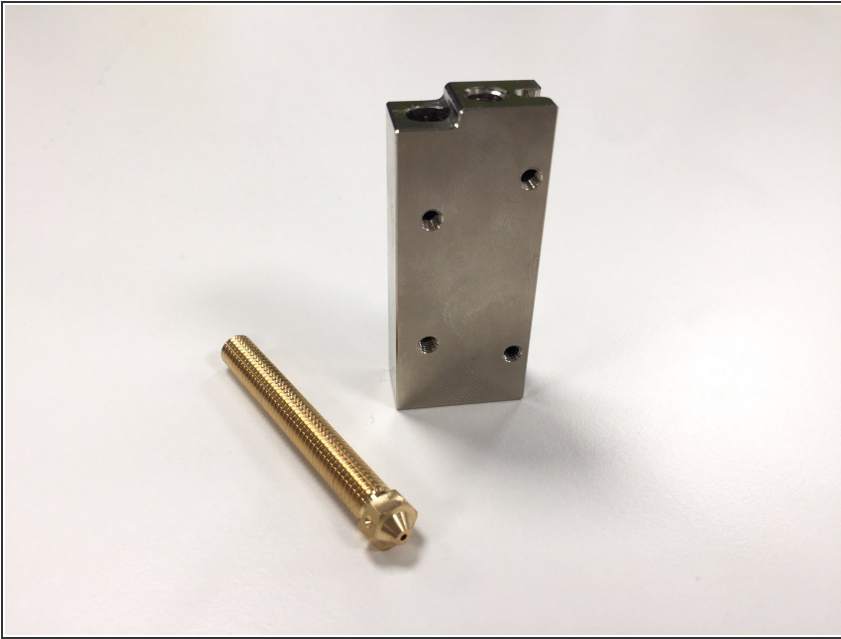

- Look for the side of the heater block that has a step in it.
- This is the top of the heater block.
- The nozzle screws into the bottom of the heater block.

Step 4 — Screw in the nozzle.

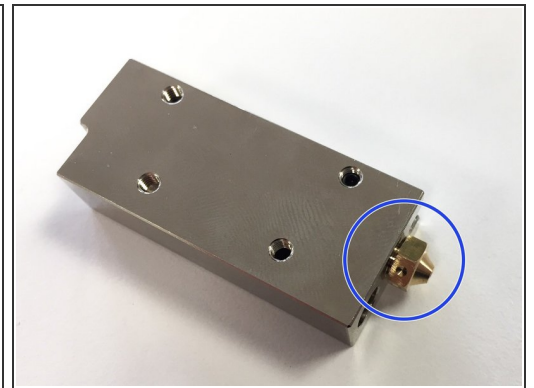
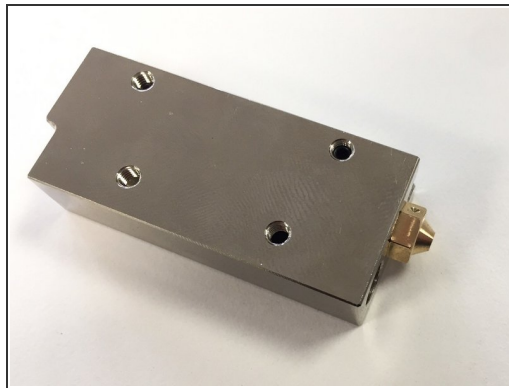
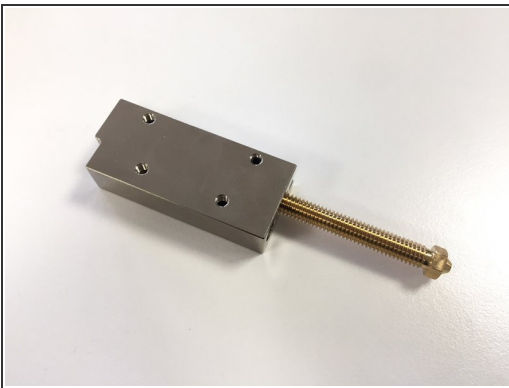

- Screw the nozzle all the way into the heater block.
- Don't worry about the tightness.
- Unscrew the nozzle 1/4 of a turn.

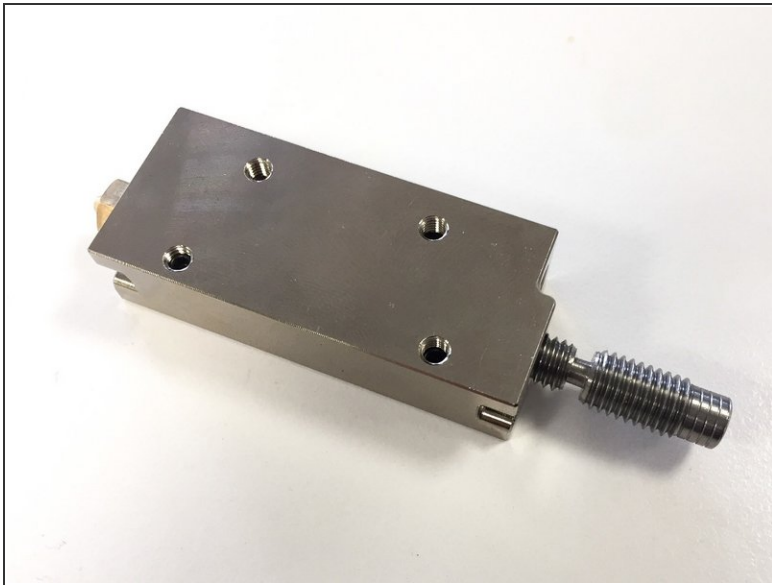
Step 5 — Screw in the heat break.

- Screw the heat break into the top of the heater block.
- Tighten the nozzle against the heat break. No need to over tighten, we'll be hot-tightening later.

Step 6 — Gather Parts.

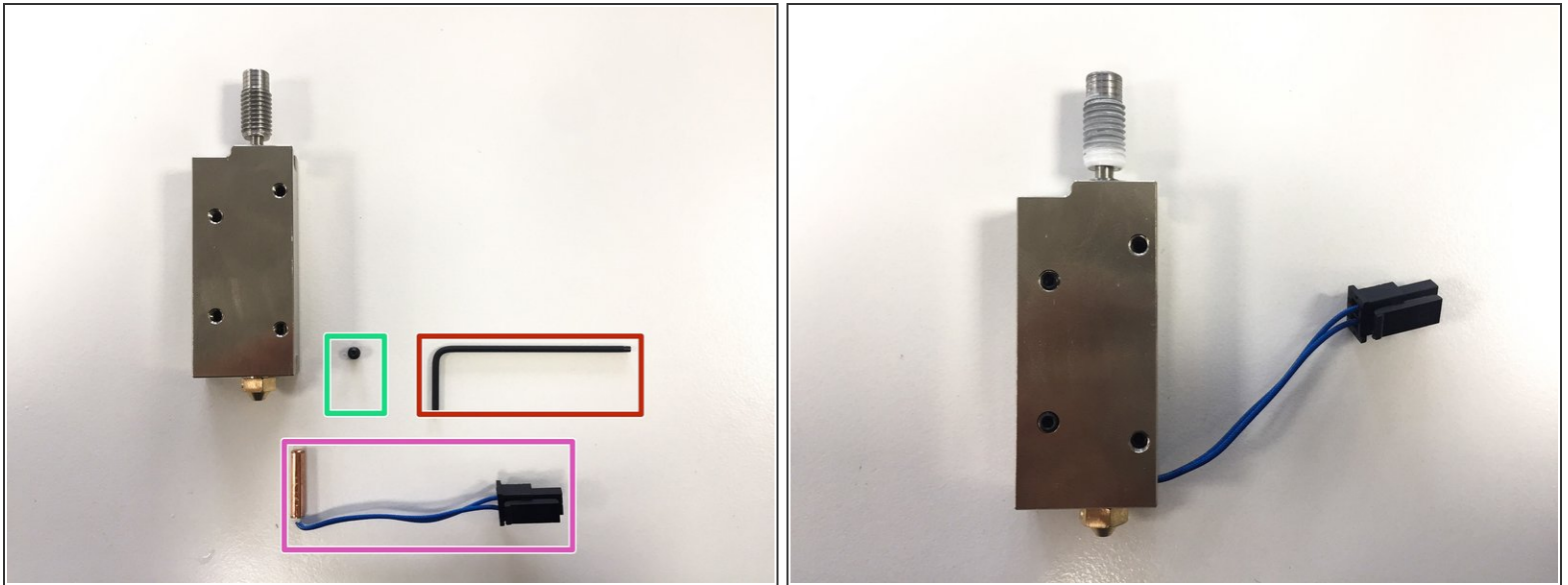

- Gather the M3 grub screw
 - 1.5mm hex wrench
 - Thermistor cartridge.
 - Insert the thermistor cartridge into the heater block and fasten the grub screw.
- ⚠ Be careful not to deform the thermistor cartridge as this can permanently damage it.

Step 7 — Check the heater cartridge.

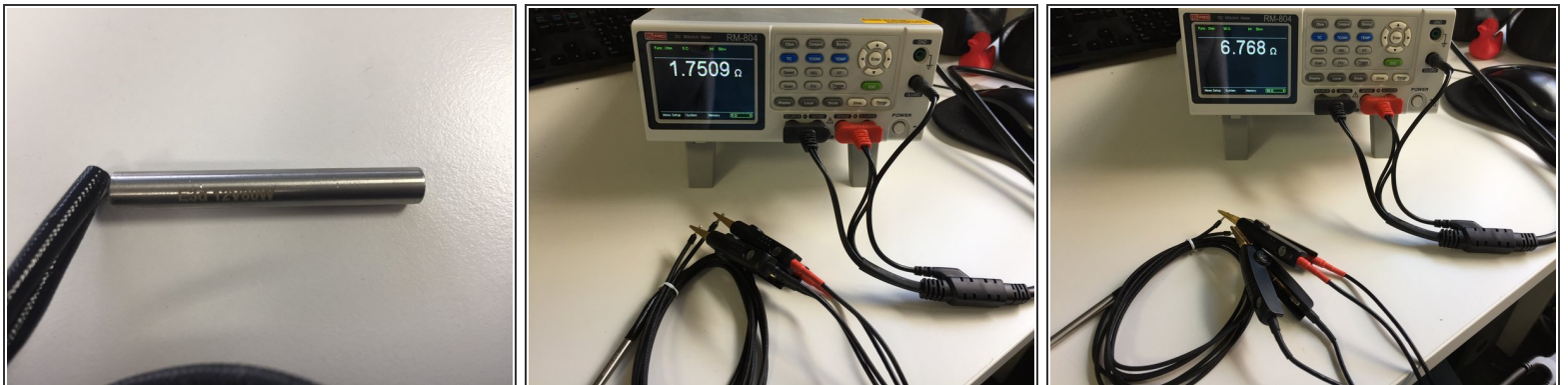

- Make sure you have the correct voltage heater cartridge for the Power supply that you are using.

Step 8

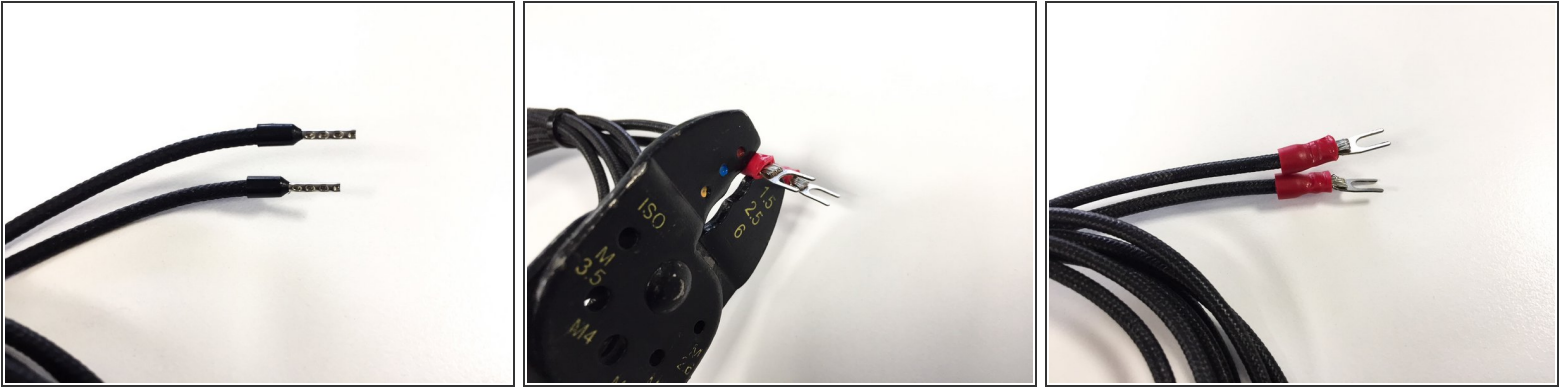

- Whilst it is possible to use the provided ferrules with the MOSFET board it is best practice to use crimped fork connectors to ensure a reliable connection.

Step 9 — Secure the heater cartridge.

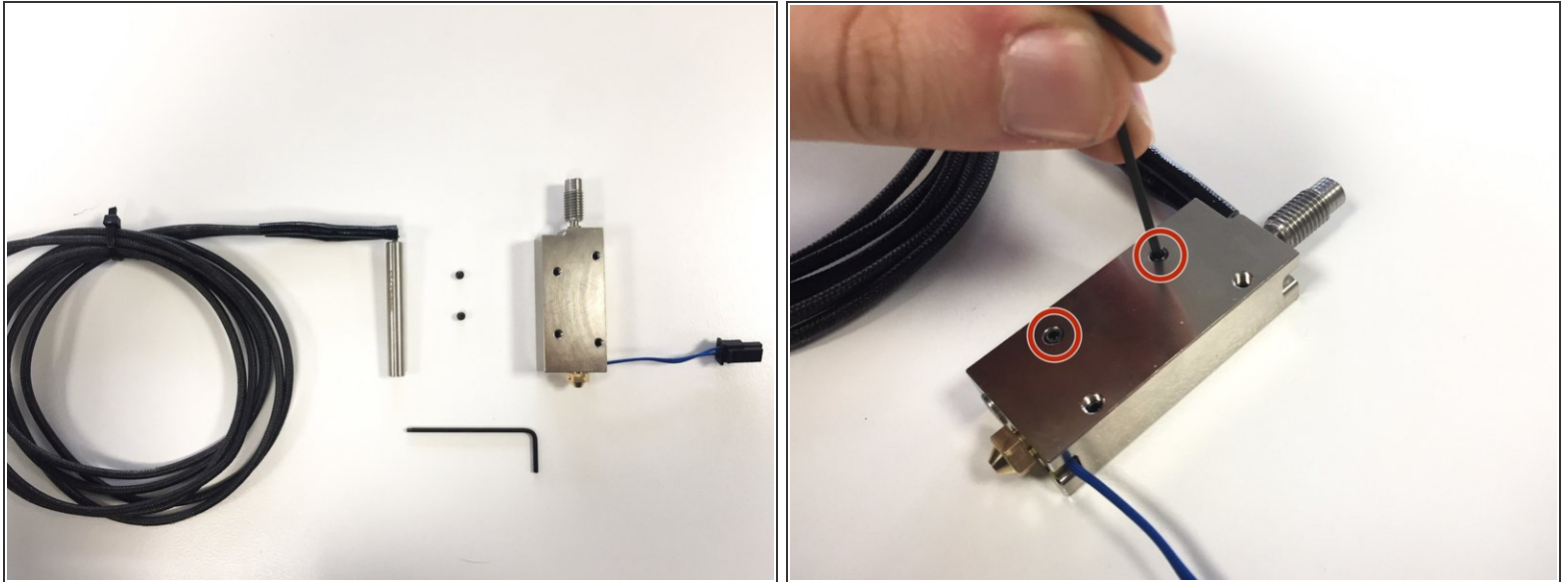

- Insert the heater cartridge into the top of the heater block.
- ⓘ You may have to gently bend the wires 90° in order for the heater block to fit underneath the heat sink.
- ⚠ Although the wire is thicker than our other heater cartridges you will still need to be careful not to snap it. Ideally you should aim to avoid a sharp radius on the bend.
- Fasten the two M3 grub screws into the Heater block to clamp down on the heater cartridge.
- Make sure the heater cartridge doesn't move when you tug at the wires gently.
- ⚠ You should also avoid fatiguing the wire, ie once you have bent it don't move the wire again.

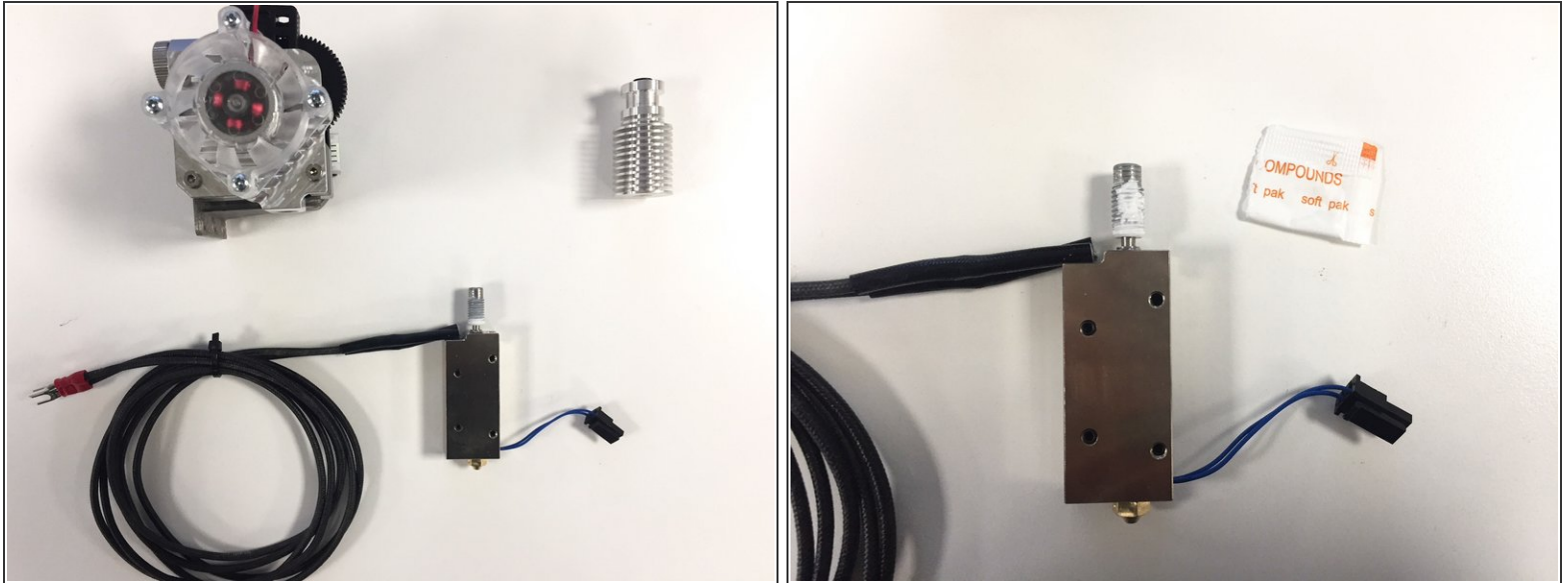
Step 10 — Gather the cold side of the hotend.

- Depending on which cold side you are using gather the required components
- Gather the heat sink compound.
- Apply the thermal compound on the heat break threads.

Step 11 — Mount the super volcano heater block.



- Mount the Super volcano heater block on your chosen cold side,
- If you need more information on assembling the chosen cold side you should follow the base guides.
- [V6 Assembly](#)
- [Titan Aero Assembly](#)
- [Titan Aqua Assembly](#)

Step 12 — Gather silicone sleeve.



- Gather the silicone glass fibre sleeve.
 - Place it on the heater block, being careful not to tug at the thermistor wire too much.
- ⚠ Remove any excess glass fibre strands, *be careful to not get any strands in your eyes or touch the glass fibre any more than you have to.*
- ⚠ If you do have to touch any of the glass fibre wear a pair of gloves.

Step 13 — Connect to the printer.

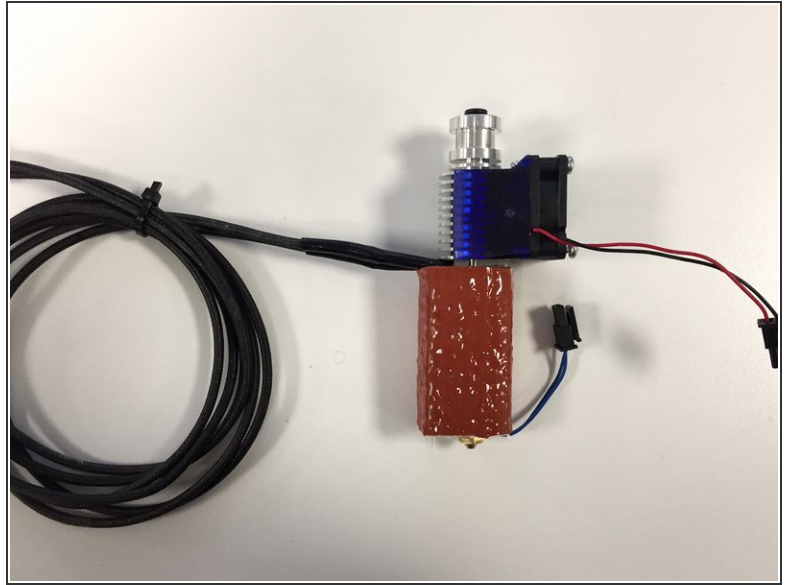
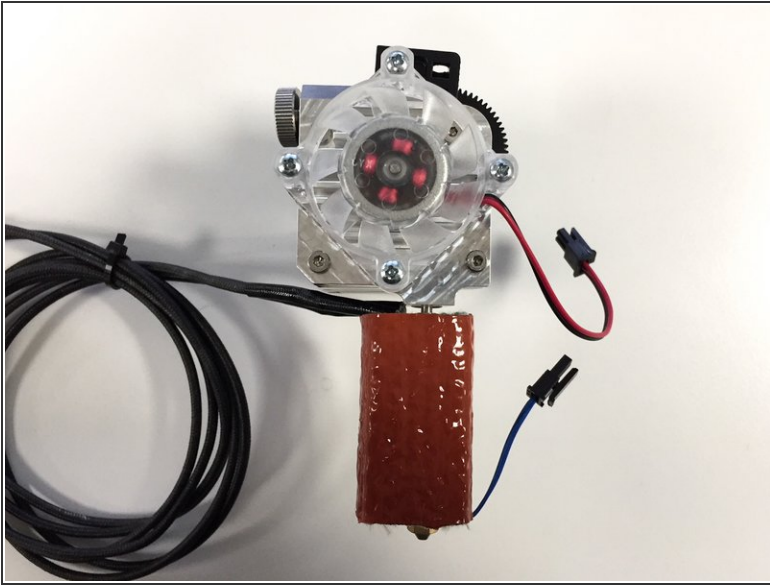

- Proceed to mounting the Hotend with the with the Super volcano to your printer.
- Connect the thermistor cartridge and fans to the Printer board.
- ⓘ We typically recommend looking on a file sharing website such as thingiverse.com for suitable mounts for your specific printer.
- 📌 If you are using an existing mount be aware that you may have to adjust the z - end stop position to accommodate the new height of the hot end.

Step 14 — Connect the heater cartridge.

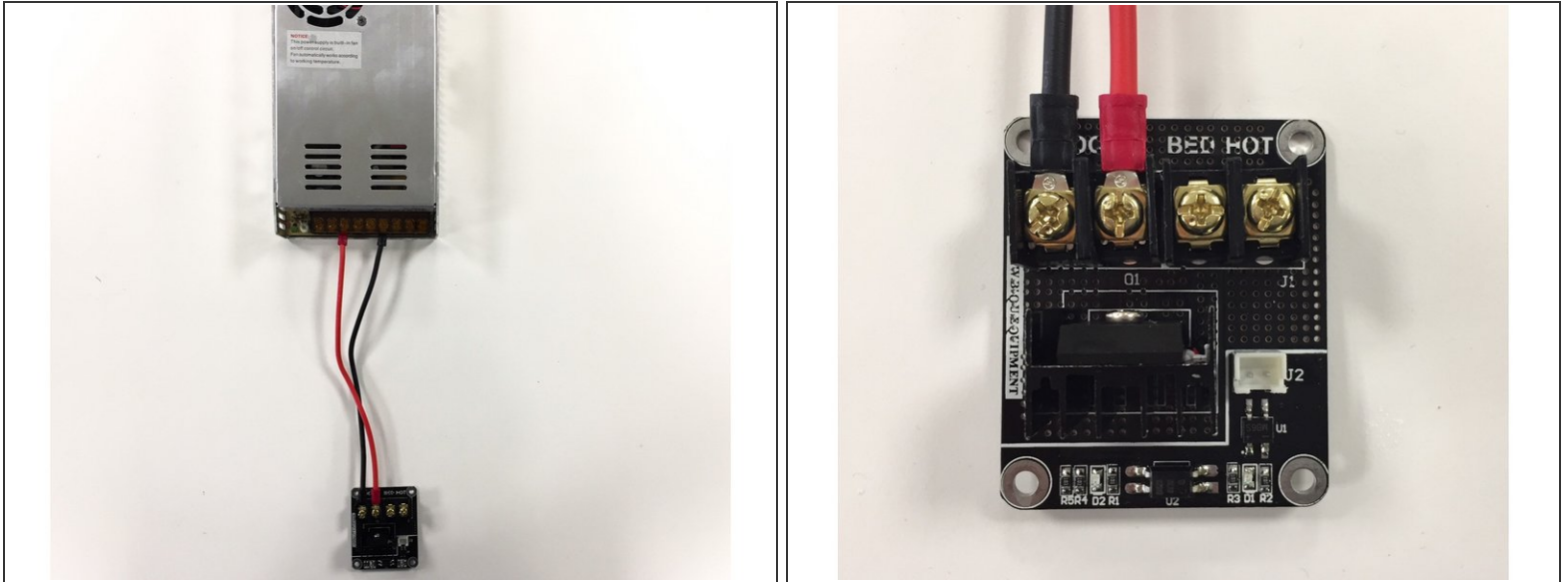

- With the 12v heater cartridge the current draw is higher than most printer boards will be able to handle. So in order to not melt the connectors on your board you will need a MOSFET.
- Connect the "Power In" side to a 12v DC power supply . Make sure you connect the +and - the correct way round.
- ⓘ If you are using the 24v heater cartridge then you can just connect the heater cartridge to the heater cartridge output from your printer board.

Step 15 — Connect the heater cartridge

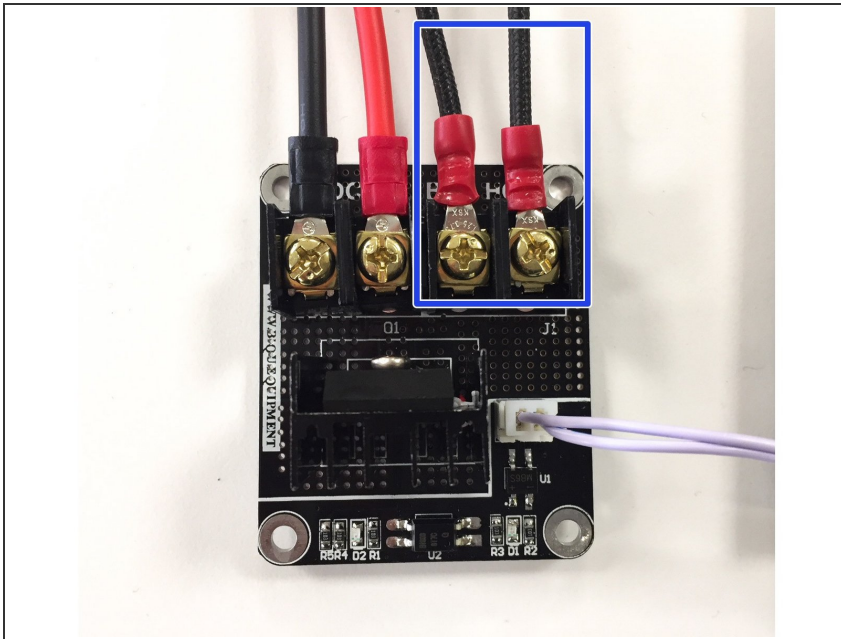

- To get a good connection between the heater cartridge and the "Heated Bed" output we recommend using the provided fork crimp connectors.
- Connect the heater cartridge to the Heated Bed output of the MOSFET (the MOSFET boards were designed for heated bed's but in this case we are using it for the heater cartridge).
- ⓘ For the heater cartridge it doesn't matter which way round you connect the wires, as the heater cartridge is not polarised.

Step 16 — Connect PWM to the board.

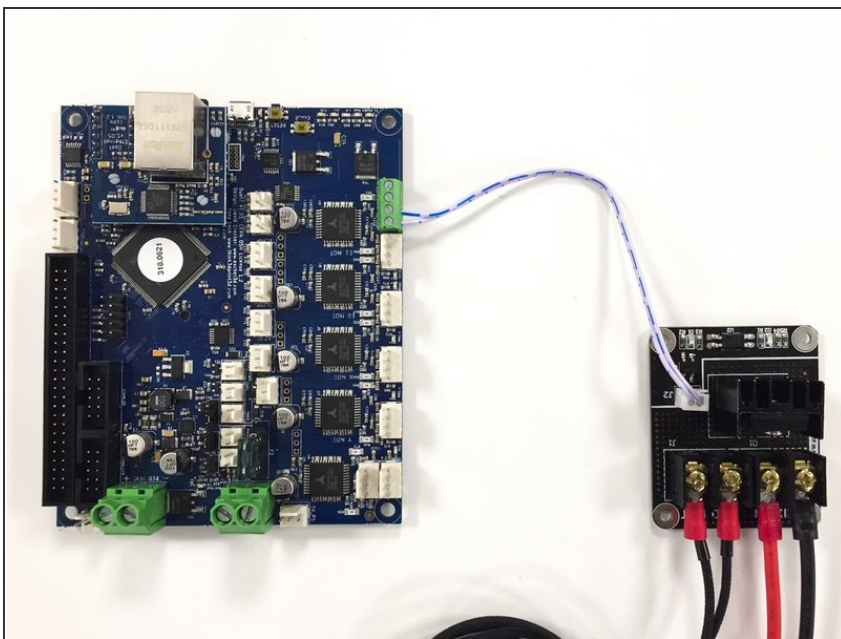

- In order to control the heater you will need to plug the MOSFET into your printers control board where the standard heater cartridge would normally connect.
- The MOSFET board should be mounted on standoffs in order to allow passive airflow and to prevent the contacts from shorting.

Step 17 — Firmware.



- If you haven't already made the necessary firmware modifications please follow the standard Titan Aero firmware modification guides.
- [Titan Aero Firmware Guides](#)

Step 18 — Hot tighten

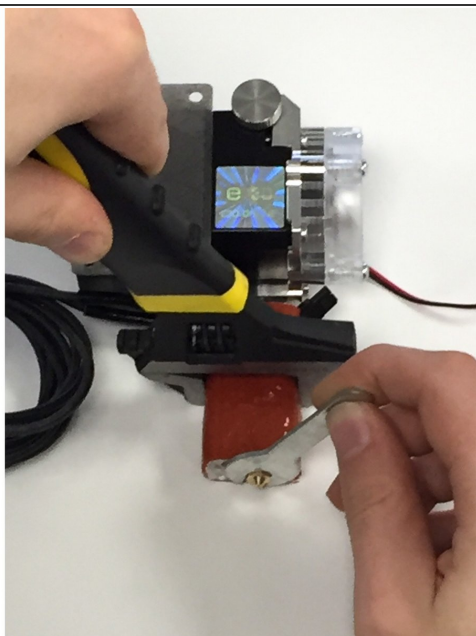

- If you are using the standard thermistor cartridge the max temperature you can print with the Titan Aero Volcano is 285°C
- Set the hotend temperature to 285°C wait for a minute for all the components to equalise in terms of thermal expansion.
- Tighten the nozzle whilst holding the super volcano heater block with a spanner to fully tighten the unit.
- We recommend 3nm of torque.

Step 19 — PID tune.



- Whenever you install a new hotend, it's important to run a PID tune. This will allow your printer to adjust some internal parameters so that it can learn how your hotend heats up. This way, your printer can anticipate how much power it needs to give your hotend to get it up to temperature, but not over.
- Use a computer to connect to your printer. If you have a typical RepRap printer, you can use PrintRun, Repetier Host, Simplify3D, or MatterControl.
- Other, closed-source, printers may be better suited to their manufacturer's recommended printer control software.